



SPECIALLY DESIGNED

FOR CHALLENGING ENVIRONMENTS | 2023/24





TOUGH FURNITURE - MEETING COMPLEX NEEDS WITH FURNITURE SOLUTIONS

For nearly 30 years now, we have been working exclusively in the field of designing, manufacturing and supplying furniture that can withstand the challenging behaviours that come with complex needs.

Working closely with our extensive client list of NHS trusts, charities, individual families, architects and care industry experts, we take our customers' real life problems and help solve them with our products. From the 270-degree hinge on our Tough Original range, to the elegant curve of our best-selling

Secure Television Cabinet, the details that make our furniture unique come from the best testing ground of all - the lives and experiences of the people who use it.

At Tough Furniture we believe that the complex needs arising from mental health conditions, learning disabilities and autism can only be met by specialist suppliers - and what's 'good enough' today, is obsolete tomorrow. Our aim is to grow and evolve as the needs of our customers do - so here's to the next 30 years....

CONTENTS

THE DETAILS THAT MATTER	4 - 5	KITCHENS	34 - 35
BEDROOM		DINING ROOM	
Tough Original	6 - 7	Tables and Chairs	36 - 37
Roxy	8 - 9		
Tough Plus	10 - 11	BESPOKE DESIGN	38
Tough Plus Options	12 - 13	FITTED FURNITURE	39
Mattresses and Bedroom Seating	14 - 15	TOUGH SEN	
		Classroom Screens	41
LOUNGE		Workstations	42
Lounge Seating and Reception Furniture	18 - 21	Computer Desks	43
Upholstery Choices	22 - 23	Storage Cupboards	44
Hopesay Lounge	24 - 25	Tables and Classroom Chairs	45
TV/Media Protection	26 - 27		
ALTV Cabinet	28 - 29	OTHER INFORMATION	
Notice Boards	30 - 31	Optional Extras	46
Mirrors / Window Protection	32 - 33	How to Order	47
		Environmental Policy	48

THE DETAILS THAT MATTER

Every component of our furniture has been carefully selected to provide the strongest, most durable construction, made safe for use in the most challenging environments – while sticking to our principle of creating as domestic a feel as possible. The key features of the entire range are highlighted here.

CABINETS



1. Carcase and fascias

Made of hard wearing wipe clean melamine faced 18mm and 25mm MDF. All corners and edges are rounded to a user friendly 2mm radius. Cabinets are delivered to you fully assembled, some large items are in sections to bolt together.



2. Drawers

Made of sturdy 12mm plywood our drawer boxes feature heavy duty steel runners with a 40kg rating. Hardened steel restraints are standard and prevent removal of the drawer from the cabinet.



3. Locks

Optional high quality locks. Either key lock or star key lock are available.



4. Back blocks

Heavy duty back blocks help to keep the carcase rigid. 8mm backs are screwed through into the back of fixed shelves for added strength and reduced ligature risk.



5. Fixings

Where visible, we use high quality tamper resistant screws.



6. Handles

All handles are bolted through the door or drawer front with tamper resistant bolts. Ligature reduction handles are available for all ranges.



7. Standard hinges

These are double cranked, to give an exceptional 270 degree opening door. This means there is no stress point where leverage will break them.



8. Strip hinges

Heavy Duty strip hinges are available as standard on our ligature reduction range of products.

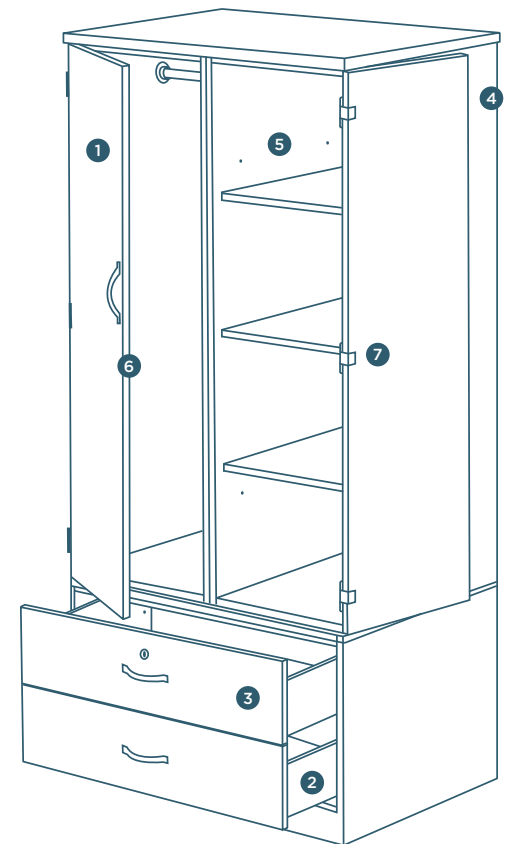



See page 40 for our full range of desks and other SEN furniture.

TOUGH ORIGINAL

This is the ever popular, original pioneering design, which established our reputation for quality and value. Suitable for environments where robust treatment shortens the serviceable lifespan of standard domestic or contract furniture.

Locks with standard or star keys and inset handles are optional extras (see page 46).



270° Hinges



Lock options



Security fixings



See our website for product updates and latest news from Tough Furniture.

TOUGH ORIGINAL BEDROOM FURNITURE



Bedside Cabinet
H637 x W410 x D437
BC



Bedside Cabinet with Drawer
H637 x W410 x D422
BCDR



Large Chest of Drawers
H890 x W810 x D525
CD8



Single Study Desk
H757 x W810 x D525
SDK



Desk & Drawer Pedestal
H757 x W1010 x D525
DDK



Double Wardrobe
H1803 x W810 x D595
DWT



Double Wardrobe with 2 Drawers
H1803 x W810 x D595
WSU





Bed and Headboard

Single 3'	H345 x W970 x L1992	SB
Three quarter 4'	H345 x W1275 x L1992	SB4
Double 4'6"	H345 x W1425 x L1992	SB46

All bed heights are to the bed platform.



Bed and Headboard with 2 Drawers

Single 3'	H345 x W970 x L1992	SB2D
Three quarter 4'	H345 x W1275 x L1992	SB2D4
Double 4'6"	H345 x W1425 x L1992	SB2D46

All bed heights are to the bed platform.



Optional Solid Bed Base

(Available for any bed)
 Single 3' **BB**
 Three quarter 4' **BB4**
 4'6" Beds supplied as standard.

TOUGH ORIGINAL BED BASES

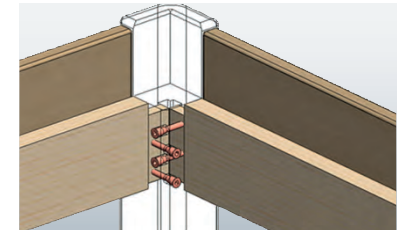

Bed base and panels are made of 18mm melamine faced MDF. Internal 24mm Birch multiply framing to provide strength and stability.



Nylon caps to the bottom of timber legs help to alleviate issues with moisture ingress.



Wall Mounted Secure Headboard

Single 3'	H550 x W958 x D18	HBS
Three quarter 4'	H550 x W1263 x D18	HBS4
Double 4'6"	H550 x W1413 x D18	HBS46



Standard Fixed Headboard

Single 3'	H500 x W946 x D18	HBD
Three quarter 4'	H500 x W1251 x D18	HBD4
Double 4'6"	H500 x W1401 x D18	HBD46



Solid beech framed headboard as standard.



28mm thick pine slats to support the mattress.



Please note
 Headboards must be ordered separately.

ROXY BEDROOM

A stylish range in a modern timber effect finish that comes with long arched handles and silver effect metal feet. Suitable for environments where robust treatment shortens the serviceable lifespan of standard domestic or contract furniture.

Locks with standard or star keys and inset handles are optional extras (see page 46).



See our website for product updates and latest news from Tough Furniture.

ROXY BEDROOM FURNITURE



Roxy Bedside Cabinet
H660 x W404 x D412
RXBC



Roxy 4 Drawer Chest
H893 x W804 x D514
RXCDS



Roxy Desk
H760 x W804 x D514
RXSDK



Roxy Double Wardrobe with 2 drawers
H1822 x W804 x D590
RXWSU



Roxy Bed & Integral Headboard
Single 3' H334 x W978 x L1962 **RXB**
Three quarter 4' H334 x W1283 x L1962 **RXB4**
All bed heights are to the bed platform.



Roxy Double Bed & Integral Headboard
Double 4'6" H334 x W1433 x L1962 **RXB46**
All bed heights are to the bed platform.



TOUGH PLUS

Our most popular and secure range, which comes with locks and wall-fixing as standard, and also includes a number of features that can help to reduce ligature risk, including inset handles, half-shelf wardrobe rails and inset strip hinges. (Also available without locks or wall fixing if preferred.)

As well as being offered in our standard beech finish, selected items from the Tough Plus range are also available in a choice of 4 modern and stylish colours: Light Elm, Dark Elm, Cream and Oak.

Sloping tops are a recommended optional extra (see page 46).

LR

Ligature reduction features



Lock options



Security fixings



See our website for product updates and latest news from Tough Furniture.

TOUGH PLUS BEDROOM FURNITURE



Tough Plus Bed

Single 3'	H333 x W970 x L1992	TPB
Three quarter 4'	H333 x W1275 x L1992	TPB4
Double 4'6"	H333 x W1425 x L1992	TPB46

All bed heights are to the bed platform.



Tough Plus Box Bed - with 2 drawers

Single 3'	H328 x W958 x L1948	TPBB2D
Three quarter 4'	H328 x W1263 x L1948	TPBB2D4
Double 4'6"	H328 x W1413 x L1948	TPBB2D46

All bed heights are to the bed platform.
Partners with wall mounted secure headboard only.



Tough Plus Box Bed - with 2 drawers

Single 3'	H328 x W958 x L1948	TPBB2D
Three quarter 4'	H328 x W1263 x L1948	TPBB2D4
Double 4'6"	H328 x W1413 x L1948	TPBB2D46

All bed heights are to the bed platform.



Tough Plus Cabin Bed

Single 3'	H525 x W970 x L1992	TPCB
Three quarter 4'	H525 x W1275 x L1992	TPCB4
Double 4'6"	H525 x W1425 x L1992	TPCB46

All bed heights are to the bed platform.



Tough Plus Box Bed

Single 3'	H328 x W958 x L1948	TPBB
Three quarter 4'	H328 x W1263 x L1948	TPBB4
Double 4'6"	H328 x W1413 x L1948	TPBB46

All bed heights are to the bed platform.
Partners with wall mounted secure headboard only.



Fixed headboard
Sold separately



Wall mounted headboard
Sold separately



Secure Shelf
H560 x W800 x D230
ALS



TOUGH PLUS BEDROOM FURNITURE



**Tough Plus
Bedside Cabinet with
Drawer and Door**
H637 x W410 x D422
TP-BCD
TPN-BCD (No Locks)



**Tough Plus
Bedside Cabinet
with Drawer**
H637 x W410 x D422
TP-BCDR
TPN-BCDR (No Locks)



**Tough Plus
Bedside Cabinet**
H637 x W410 x D422
TP-BC2
TPN-BC2 (No Locks)



**Tough Plus
Open Bedside Cabinet**
H637 x W410 x D422
TP-BCO



**Tough Plus
Open Storage Unit**
H700 x W750 x D500
TP-CDO



**Tough Plus
Chest of Drawers**
H890 x W810 x D525
TP-CD8
TPN-CD8 (No Locks)



**Tough Plus
Single Study Desk**
H757 x W810 x D525
TP-SDK



**Tough Plus
Desk & Drawer Pedestal**
H757 x W1010 x D525
TP-DDK
TPN-DDK (No Locks)



**Tough Plus
Double Wardrobe**
H1803 x W810 x D595
TP-DWT
TPN-DWT (No Locks)



**Tough Plus
Open Wardrobe/Shelf
Unit**
H1803 x W810 x D595
TP-WOW



**Tough Plus
Double Wardrobe
with 2 Drawers**
H1803 x W810 x D595
TP-WSU
TPN-WSU (No Locks)



Sloping Tops
Available for all wardrobe and tall storage units
SP2
Double Wardrobe

TOUGH PLUS COLOUR OPTIONS



Long Membrane Pressed Full Length secure mirror
H1300 x W490 x D25
MMLV



Secure mirror
H570 x W490 x D25
MMV



Tough Plus Bedside Cabinet
H637 x W410 x D422
TP-BC2
TPN-BC2 (No Locks)



Tough Plus Chest of Drawers
H890 x W810 x D525
TP-CD8
TPN-CD8 (No Locks)



Tough Plus Double Wardrobe with 2 Drawers
H1803 x W810 x D595
TP-WSU
TPN-WSU (No Locks)



Tough Plus Box Bed
Single 3' H328 x W958 x L1948 **TPBB**
Three quarter 4' H328 x W1263 x L1948 **TPBB4**
Double 4'6" H328 x W1413 x L1948 **TPBB46**
All bed heights are to the bed platform.



TV Cabinet
H952 x W914 x D168 TV Size 32" **ALTV32**
H1089 x W1151 x D168 TV Size 43" **ALTV43**
H1152 x W1294 x D168 TV Size 50" **ALTV50**
H1215 x W1414 x D168 TV Size 55" **ALTV55**
Comes with Flush to Wall TV Bracket.



Wall Mounted Secure Headboard
Single 3' H550 x W958 x D18 **HBS**
Three quarter 4' H550 x W1263 x D18 **HBS4**
Double 4'6" H550 x W1413 x D18 **HBS46**



TOUGH PLUS COLOUR OPTIONS

These items are available in 5 colour options

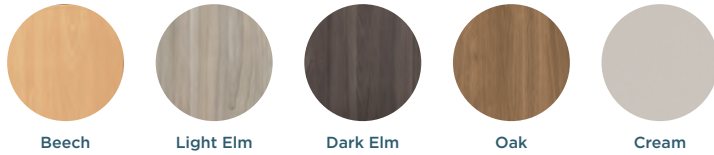

Beech Light Elm Dark Elm Oak Cream



TOUGH PLUS BED BASES



Solid beech timber leg with 18mm melamine faced MDF panels edged with 2mm ABS edging tape.



Mortice & Tenon joints. Solid 24mm Plywood bearer with heavy duty steel clips, creating a robust bed frame.



Nylon caps to the bottom of timber legs help to alleviate issues with moisture ingress.



A reinforcement bar that sits below the solid bed base, giving extra support and strength to all beds.

MATTRESSES & BEDROOM SEATING

All mattresses comply with BS7177 Ignition source 5 Medium Hazard Classification.

Our SCM, HM and FB models are also available in Crib 7.



MATTRESSES



Moisture Resistant Mattress

13.5 gauge interior sprung

Single 3'	H180(7") x W900 x L1900(6'3")	WP
Three quarter 4'	H180(7") x W1200 x L1900(6'3")	WP4
Double 4'6"	H180(7") x W1350 x L1900(6'3")	WP46



Secure Mattress

Solid foam core and vinyl cover with stitched and heat sealed seams. Waterproof, wipe clean, hygienic and tear resistant for challenging environments.

Single 3'	H180(7") x W900 x L1900(6'3")	SCM
Three quarter 4'	H180(7") x W1200 x L1900(6'3")	SCM4
Double 4'6"	H180(7") x W1350 x L1900(6'3")	SCM46

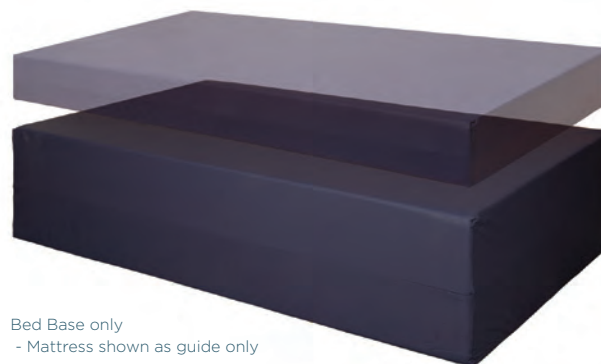

Bed Base only
- Mattress shown as guide only

Foam Bed Base

Solid foam base with soft breathable PU cover with heat welded seams. Fully waterproof, wipe clean and hygienic. For use with soft touch foam mattress shown above. (Also available with the same tear resistant vinyl cover as the SCM).

Single 3'	H450 (18") x W900 x L1900(6'3")	FB
	Tear Resistant Covering	FB-V
Three quarter 4'	H450 (18") x W1200 x L1900(6'3")	FB4
	Tear Resistant Covering	FB4-V
Double 4'6"	H450 (18") x W1350 x L1900(6'3")	FB46
	Tear Resistant Covering	FB46-V

Crib 5 Crib 7



Soft Touch Foam Mattress

Soft and breathable PU cover with heat welded seams, fully waterproof, wipe clean and hygienic.

Single 3'	H180(7") x W900 x L1900(6'3")	HM
Three quarter 4'	H180(7") x W1200 x L1900(6'3")	HM4
Double 4'6"	H180(7") x W1350 x L1900(6'3")	HM46



Bed Protection Tray

Moulded plastic tray to fit into the bed well of a single bed, providing hygienic management of incontinence problems.

Fits all single beds except Roxy beds.

PT PTB (for TPBB)



See page 22 for upholstery choices



Cleaning and maintenance

Details of recommended cleaning and maintenance information arrive with the delivery and can also be obtained from our website: www.toughfurniture.com/services/maintenance-cleaning/

BEDROOM SEATING



Padded Dining Chair
H490seat x W480 x D590
DC6



Obley Foam De-escalation Chair
H820 x W550 x D860
OBY



Caynham Tub Chair
H750 x W700 x D700
CAY

35kg total weight



Radnor Tub Chair
H790 x W777 x D650
RAD

37kg total weight
Optional extra 10kg weighting



Foam Cube
H450 x W450 x D450
CUBE



Foam Cylinder
H450 x W450 x D450
CYL



Adult Bean Bag with Inner Liner
H1000 x W850 x D850
BEAN

Crib 7 version
BEAN-7



Child Bean Bag with Inner Liner
H750 x W730 x D700
BEAN-C

Crib 7 version
BEAN-C7





 See page 12 for our Tough Plus options range.







See page 18 for
our full range of
lounge furniture.

LOUNGE SEATING

Our high durability lounge seating is specified to complement our existing furniture ranges and deliver the same rugged good service and long-term value. Our seating range is also backed by a maintenance repair service.

A Polycarbonate base is an optional extra (see page 46).

We also offer a range of Severe Contract quality fabric options (see page 22).

- 
No visible staples
- 
Solid plywood interior
- 
Fire retardant
- 
MRSA resistant

 See page 22 for upholstery choices

 See our website for product updates and latest news from Tough Furniture.

LOUNGE SEATING



Stokesay Armchair
H940 x W930 x D870
STO fabric A
STO-B fabric B



Stokesay Medium Sofa
H940 x W1500 x D870
STO-2 fabric A
STO-2-B fabric B
Stokesay Large Sofa
H940 x W1800 x D870
STO-3 fabric A
STO-3-B fabric B

Piping to cushion



Corfton Armchair
H900 x W820 x D850
COR fabric A
COR-B fabric B



Corfton Medium Sofa
H900 x W1360 x D850
COR-2 fabric A
COR-2-B fabric B
Corfton Large Sofa
H900 x W1900 x D850
COR-3 fabric A
COR-3-B fabric B

Piping to cushion



Wenlock Armchair
H815 x W970 x D890
WEN fabric A
WEN fabric B



Wenlock Medium Sofa
H815 x W1580 x D890
WEN-2 fabric A
WEN-2-B fabric B
Wenlock Large Sofa
H815 x W1835 x D890
WEN-3 fabric A
WEN-3-B fabric B

Piping to cushion

LOUNGE SEATING



All frames are fully lined to all faces, creating durability and strength.



Our lounge seating features a solid plywood base. Feet and bases are fastened with security fittings, and there are no visible staples.



Sibdon Armchair
H820 x W680 x D720
SIB fabric A
SIB-B fabric B



Yarpole Armchair
H790 x W920 x D810
YAR fabric A
YAR-B fabric B

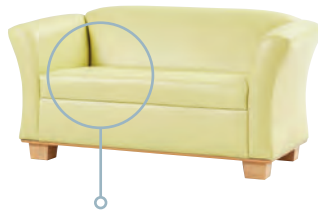

Fixed cushions

Yarpole Medium Sofa
H790 x W1580 x D810
YAR-2 fabric A
YAR-2-B fabric B
Yarpole Large Sofa
H790 x W2030 x D810
YAR-3 fabric A
YAR-3-B fabric B



Stretton Armchair
H960 x W700 x D760
STR fabric A
STR-B fabric B



Stretton Medium Sofa
H960 x W1200 x D760
STR-2 fabric A
STR-2-B fabric B



Orleton Armchair
H900 x W820 x D850
ORL fabric A
ORL-B fabric B



Orleton Medium Sofa
H900 x W1360 x D860
ORL-2 fabric A
ORL-2-B fabric B
Orleton Large Sofa
H900 x W1900 x D850
ORL-3 fabric A
ORL-3-B fabric B



Capped Orleton Armchair
H900 x W820 x D850
ORL-ARM fabric A
ORL-ARM-B fabric B



Capped Orleton Medium Sofa
H900 x W1360 x D850
ORL-ARM-2 fabric A
ORL-ARM-2-B fabric B
Capped Orleton Large Sofa
H900 x W1900 x D850
ORL-ARM-3 fabric A
ORL-ARM-3-B fabric B



Ludlow Armchair
H780 x W830 x D870
LUD fabric A
LUD-B fabric B



Ludlow Medium Sofa
H780 x W1300 x D840
LUD-2 fabric A
LUD-2-B fabric B
Ludlow Large Sofa
H780 x W1550 x D840
LUD-3 fabric A
LUD-3-B fabric B



Dorrington Armchair
H985 x W790 x D845
DOR fabric A
DOR-B fabric B



Dorrington Medium Sofa
H985 x W1450 x D845
DOR-2 fabric A
DOR-2-B fabric B
Dorrington Large Sofa
H985 x W1840 x D845
DOR-3 fabric A
DOR-3-B fabric B

LOUNGE SEATING



Brampton Occasional Chair
H457 seat x W737 x D737
BRC



Caynham Tub Chair
H750 x W700 x D700
CAY
fabric A
fabric B
35kg total weight



Adult Bean Bag with Inner Liner
H1000 x W850 x D850
BEAN

Crib 7 version
BEAN-7



Child Bean Bag with Inner Liner
H750 x W730 x D700
BEAN-C

Crib 7 version
BEAN-C7



Obley Foam De-escalation Chair
H820 x W550 x D860
OBY



Obley Medium Foam Sofa
H820 x W1100 x D860
OBY-2

Obley Large Foam Sofa
H820 x W1650 x D860
OBY-3



Obley Large Foam De-escalation Sofa
H820 x W1656 x D970
OBY-D3



Radnor Tub Chair
H790 x W777 x D650
RAD
fabric A
fabric B
37kg total weight
Optional extra 10kg weighting



Radnor Medium Sofa
H730 x W1200 x D650
RAD-2
fabric A
fabric B
57kg total weight
Optional extra 10kg weighting
Optional extra 20kg weighting



Foam Cube
H450 x W450 x D450
CUBE



Foam Cylinder
H450 x W450 x D450
CYL

RECEPTION FURNITURE

BURLEY



Suggested arrangement.



Burley Centre Unit
H870 x W535 x D730
BUR-C



Burley Table
H480 x W730 x D730
BUR-T



Burley Left Hand / Right Hand Unit
H870 x W700 x D730
Please advise LH or RH when ordering
BUR-E



Burley Corner Unit
H870 x W710 x D730
BUR-CO

COLSTEY

Designed for inside or outside use with a comfortable, modern look and available in a range of up to date colours. The products can be weighted with sand if required to make them more difficult to move or throw.



Colstey Chair (10kg)
H750 x W650 x D670
(420 s/height)
COL

Option to increase product weight to 47kg



Colstey Medium Sofa (25kg)
H750 x W1190 x D670
(420 s/height)
COL-2

Option to increase product weight to 100kg



Colstey Table
H750 x W650 x D670
(420 s/height)
COL-T

Colour Options

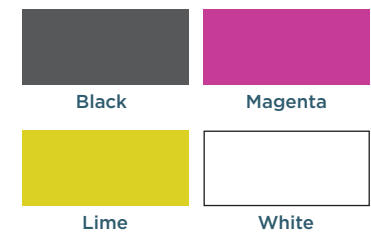

UPHOLSTERY CHOICES

Tough Furniture are proud to offer a growing range of seating options for bedrooms and communal areas, including sofas, armchairs, foam seating and desk chairs. All of our seating is available in a choice of 3 price bands, which reflect varying levels of fire resistance, durability, and infection control.



UPHOLSTERY OPTION A

- Crib-5 Fire resistance
- MRSA resistant
- Waterproof and wipeable
- Vinyl and Fabric options available

UPHOLSTERY OPTION B

- Crib-7 Fire resistance
- MRSA resistant
- Waterproof and wipeable
- Vinyl only

UPHOLSTERY OPTION C

- Crib-5 Fire resistance
- Si-Leather™ (Silicon-based vinyl for extra robustness)
- MRSA resistant
- Waterproof and wipeable
- Enhanced cleaning features
- Environmentally friendly



See our website for product updates and latest news from Tough Furniture.



HOPESAY LOUNGE

The Hopesay Lounge Collection is made to our high build specification, providing you with durability, quality and value for money. Utilising modern materials in a contemporary oak finish, this range helps create a fresh, homely feel within complex needs environments.

Doors and locks available as fully lockable.

Inset handles are an optional extra (see page 46).

Shatterproof
Polycarb

LR
Ligature reduction
features

Lock
options

 - For optional extras and locks see page 46

HOPESAY LOUNGE STORAGE UNITS



Double Sideboard
H784 x W823 x D465
HLSB2



Triple Sideboard
H784 x W1306 x D465
HLSB3



Large Coffee Table
H400 x W1000 x D600
HLCTL



Small Coffee Table
H400 x W600 x D600
HLCTS



Double Dresser Unit
H1705 x W823 x D465
HLSB4



Zig Zag Bookcase
H1810 x W694 x D355
HLZ

HOPESAY LOUNGE MEDIA DISPLAY UNITS



Full Rig TV Unit
 TV & DVD Protection with locking polycarbonate screens, shelves, removable panel and media base unit
 H1468 x W1512 x D438
TV Size 37" - 42" **HLTV1**



Wall Mounted TV Cabinet & Media Base Unit
 TV & DVD Protection with locking polycarbonate screens
 Top H787 x W1141 x D203
TV Size 37" - 42" **HLTV2**
 Base H507 x W1506 x D438



Secure Media Base Unit
 With locking polycarbonate protection to DVD section
 H507 x W1506 x D438 **HLTV2-Base**



Media Base Unit
 H507 x W1506 x D438 **HLTV3**



TV/MEDIA PROTECTION

Our range of TV and Media protection cabinets feature lockable screens constructed from high quality polycarbonate which is safe and immensely strong. As well as offering full protection to TVs and other media devices in challenging environments, their domestic, elegant design also goes a long way towards creating a welcoming, homely atmosphere.

Please note:

TV & DVD players on these pages are not included. We also recommend that all polycarbonate cabinets are wall fixed for added security.

- 

Shatterproof
Polycarb
- LR

Ligature reduction
features
- 

Lock options

 **Please note**
TV & DVD players on these pages are not included. We also recommend that all polycarbonate cabinets are wall fixed for added security.

TV/MEDIA PROTECTION



TV Cabinet
H1066 x W910 x D488
TV Size 32"
FS32

H1203 x W1147 x D488
TV Size 43"
FS43

H1266 x W1290 x D488
TV Size 50"
FS50



Wall Mounted TV Cabinet
H633 x W904 x D203
TV Size 32"
WMTV32

H770 x W1141 x D203
TV Size 43"
WMTV43

H831 x W1284 x D203
TV Size 50"
WMTV50



Corner TV Cabinet
H1066 x W1155 x D718
TV Size 32"
CTV32



Wall Mounted TV/DVD Cabinet
Wall mounted TV cabinet to house large TVs with built in side loading DVD.
H607 x W904 x D203 TV Size 32"
WMTV32-DVD

POLYCARBONATE SCREENS



High strength polycarbonate vision panel.

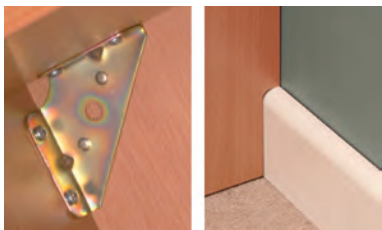

Wall fix and skirting notch preparation to easily secure cabinets.



Fixed Computer Work Station

H1300 x W1050 x D730

Desk Height 760

Monitor Size 19"

FCWS





SECURE TV CABINETS

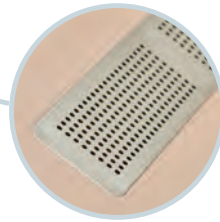

Ventilation panels to regulate temperature and sound quality

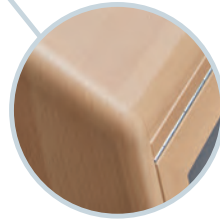

Sloping top and bottom for ligature reduction



 See for yourself on YouTube, how tough our furniture really is!



Flush to Wall TV Bracket 22"-55" TVBR (if bought separately)

BEST SELLER

TV Cabinet

H952 x W914 x D168 TV Size 32"

ALTV32

H1089 x W1151 x D168 TV Size 43"

ALTV43

H1152 x W1294 x D168 TV Size 50"

ALTV50

H1215 x W1414 x D168 TV Size 55"

ALTV55

Comes with Flush to Wall TV Bracket.

These items are available in 5 colour options



Beech



Light Elm



Dark Elm



Oak



Cream



NOTICE BOARDS



Secure Notice Board
H676 x W876 x D56
ALNB1



Secure Medium Notice Board
H876 x W876 x D56
ALNB2



Secure Large Notice Board
H876 x W1276 x D56
ALNB3





MIRRORS



Long Membrane Pressed Full Length secure mirror
H1300 x W490 x D25
MMLV



Anti-ligature corner detail



Secure mirror
H570 x W490 x D25
MMV



WINDOW PROTECTION / SECONDARY GLAZING



Polycarbonate Window Protection with Ventilation

Our lockable polycarbonate window protection unit is rapidly becoming a customer favourite. Constructed in solid ash timber frame with extra security features such as star key locks, strengthened dovetail joints and our shatterproof polycarbonate screen, it allows users to control all access to a room's windows, and can also be used to restrict access to curtains and blinds. All units are bespoke designed to fit your precise requirements and can be constructed with single or double opening apertures as required. Prices on application.

£POA - call 01588 674 340 or e-mail sales@toughfurniture.com for enquiries.

Made to order to suit all window types.



KITCHENS

We supply kitchen units made to 'Tough Furniture' specification, which have proved very popular for residential units and life skills training areas. Full layout drawings for installers are supplied with the job and we are happy to either design a layout with the customer, or work from their architect / designer's brief. If you require more detailed information regarding our kitchens, please don't hesitate to contact us.



Please enquire for more information on our full kitchen range.



See our website for product updates and latest news from Tough Furniture.



Drawerline base units



3 Drawer stacks



Hiline base unit



Base Elec. Appliance housing



Tall larder unit



Oven housing



Sink bases



Wall cupboards



Worktop and splash backs by Bushboard available in 'Omega' or 'Option' ranges (excluding High Gloss finish)



TABLES & CHAIRS

Our tables are built to very high standards. Using only the best materials available, we have created a range of stylish tables with hidden strengths that make them suitable for challenging environments.



Fire retardant



MRSA resistant

*Our Height-Adjustable tables feature a unique telescopic leg which is easy to adjust, and securely fits into a specially constructed top to deliver both the trademark 'Tough Furniture' strength and complete accessibility. The tables have a variety of applications as well as being ideal for wheelchair provision.

**Our Tough Plus table is constructed from solid beech timber, featuring an additional cross brace to make it even stronger than our standard table. This table has a flooring grade laminate top which is impact resistant and hygienic.



See our website for product updates and latest news from Tough Furniture.

TABLES



Round Table
Seats 4
H760 x Dia. 1100
RT4



Tough Plus Table
Seats 4
H760 x Dia. 1100
****TP-RT4**



Square Table
Seats 4
H760 x W900 x L900
T1



Rectangular Table
Seats 6
H760 x W900 x L1500
T2
Seats 6/8
H760 x W900 x L1800
T3



Rectangular Table
Seats 8
H760 x W900 x L2100
T4



Rectangular
Height adjustable x L1500 x W900
***HT2-S**
Height range 530-730
***HT2-T**
Height range 730-930



Square
Height adjustable
x L900 x W900
***HT1-S**
Height range 530-730
***HT1-T**
Height range 730-930

TABLES



All table tops are made from 25mm MDF faced with a flooring grade laminate.



Responsibly sourced solid beech timber framing, featuring mortice and tenoned joints for superior strength.

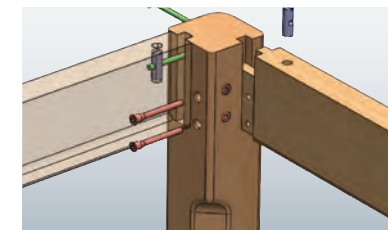

Designed and built with hidden strengths. Joints are reinforced with steel dowels and bolts.



Nylon caps to the bottom of timber legs help to alleviate issues with moisture ingress.

CHAIRS

Dining Side Chair
H430 Seat x W517
x D610
DC1

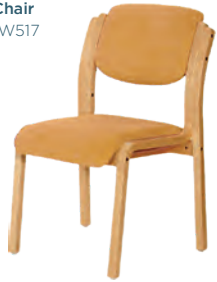

Dining Armchair
H430 Seat x W517
x D610
DC2



Dining Armchair
H430 Seat x W525
x D600
DC3



Dining Chair
H460 Seat x W460 x
D530
DC4
Padded Seat
Option
DC4W
Wooden Seat
Option



Dining Chair with Arms
H460 Seat x W460 x
D530
DC5
Padded Seat
Option
DC5W
Wooden Seat
Option



Wooden Side Chair
H445 Seat x W490 x
D540
WC1



Wooden Armchair
H445 Seat x W490 x
D540
WC2



Skids
(available for all
dining chairs)
SKD



Padded Dining Chair
H490 seat x W480
x D590
DC6



Secure Stool
H470 x W500
x D500
DC7



**Fully Upholstered
Side Chair**
H870 x W460
x D490
460 seat height
DC10



**Fully Upholstered
Side Chair with Arms**
H870 x W540
x D530
460 seat height
DC11



Bistro Chair
H830 x W500
x D565
450 seat height
DC14



Please note

Chairs can be vulnerable things at the best of times. We have sourced good quality and cost effective styles from specialist manufacturers (delivered directly) and the feedback has been good, though we would not recommend them for extremely severe use locations.

Both the upholstered squabs and the laminate frames of the DC1, DC2 and DC3 range of chairs can be separately replaced, extending their lifetime. These products are budget friendly and easy to maintain.

BESPOKE DESIGN SERVICE

As the UK's only company specialising exclusively in manufacturing furniture for mental health, learning disabilities and autism care our focus on matching exactly the right product to our customer's needs is second to none.

We are very much at home adapting our furniture to fit the specific needs of any complex needs care environment, and can operate on the scale of an individual home, right up to the biggest design and build projects in mental health care development.

We thrive on the challenge of bespoke design, so if that's your requirement, here's how it works:

1. You identify the specific problem you need our furniture to solve
2. If your bespoke requirement is fairly straightforward, drop us a line at sales@toughfurniture.com or call us on **01588 674 302** to let us know what you're looking for.
3. If it's a bit more complicated, we can arrange a site visit from one of our area sales managers to get a detailed view of your situation..
4. Once we've gathered all the information we can, this is passed on to our in-house design team who will come up with a design concept and drawings.
5. We liaise with you to refine the concept until it genuinely matches your specific requirements - and then it's a short journey from our design department to the factory floor.



Please note

As of 2023 minimum order quantities for bespoke products will apply. For all enquiries relating to this please call **01588 674340**



FITTED FURNITURE

The qualities and features of the Tough Furniture concept can be easily adapted for fitted furniture. Our cost-effective modular approach means that individual units in any of our installations can easily be replaced. This gives the added value of long term easy maintenance and the flexibility to alter room layouts to suit changing circumstances.

Contact our sales and customer service team direct to use our free room design and quotation service:

Tel - 01588 674 340

E-mail - sales@toughfurniture.com



Furniture modules can be removed for repair while the rest remains in situ.



TOUGH SEN

As complex needs specialists, at Tough Furniture we have developed a growing range of furniture products specifically for the SEN environment. As well as our usual commitment to robustness and an attractive appearance, our SEN range also features items that have been designed specifically with autism in mind, such as our classroom screen dividers and personalised work stations.

As with all Tough Furniture products, we are always looking to expand the range of options we can offer, so if you have an SEN furniture need that we don't currently meet, please drop us a line at sales@toughfurniture.com



CLASSROOM SCREENS

These screens are made from heavy duty 25mm melamine faced MDF and are faced on both sides with an acoustic fabric panel for sound attenuation (see colour options below) which can also be used as a noticeboard for Velcro, pins and other material fastenings.

Screen Configuration

The screens can be used to create all manner of shapes and spaces within the classroom for quiet or 'chill out' areas and they can be used in conjunction with other items such as our workstations or tables which can easily be reconfigured as needs change. We recommend the optional brackets (as illustrated) which join together the tops of the screens, allowing you to configure a sturdy, more secure layout of your choice.

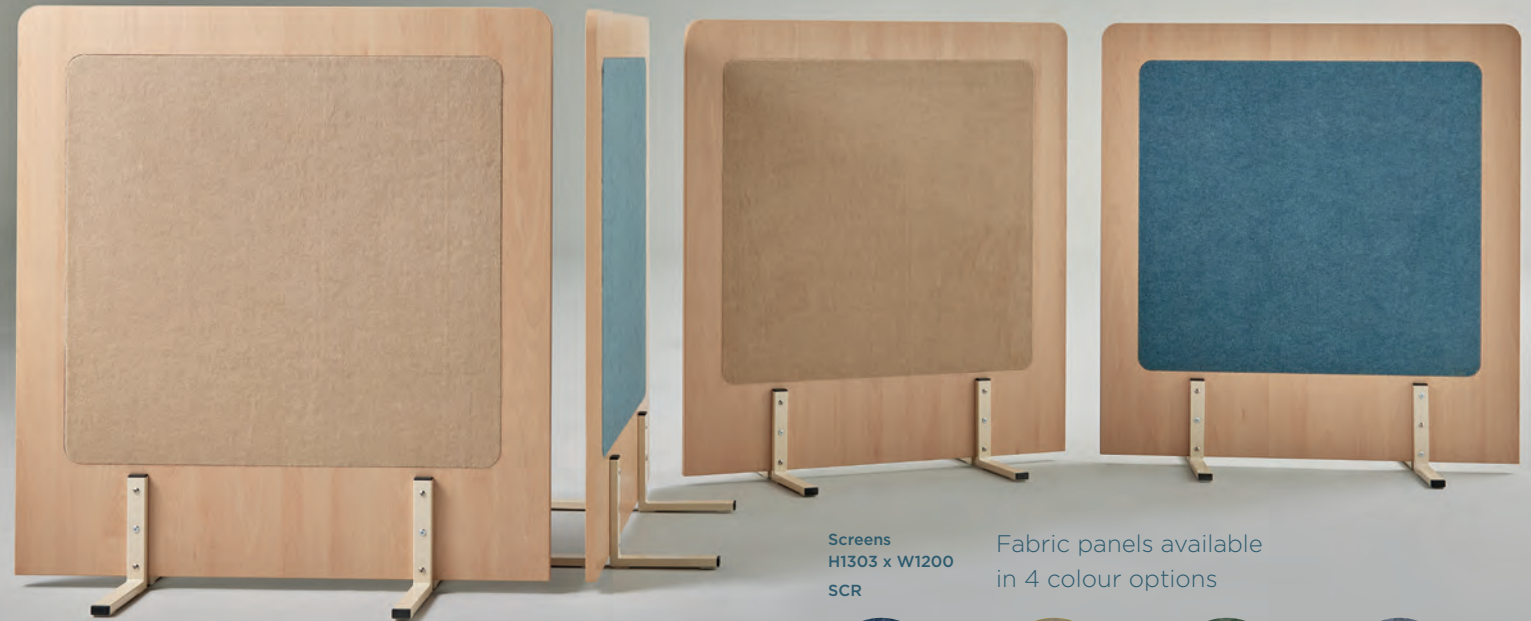

Screens
H1303 x W1200
SCR

Fabric panels available
in 4 colour options

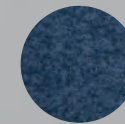

Azure

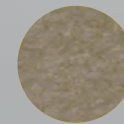

Butter

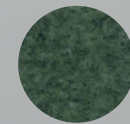

Sage

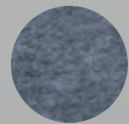

Silver



BRACKETS



X-Shape Bracket
SFX



T-Shape Bracket
SFT

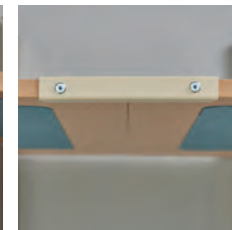

Straight Bracket
SFS



L-Shape Bracket
SFL

WORKSTATIONS

This range of heavy duty workstations are designed to create a distraction free space to aid concentration and focus in SEN environments. They are available in a choice of sizes and can be augmented with a variety of optional shelf and storage units. These items are delivered and assembled onsite by our delivery team.

Under Desk Storage

Under desk storage for workstations, designed to hold 3 shallow classroom trays. Double option available on WS4 workstations with single option (right-hand or left-hand) available on WS2 workstations.

Small Workstations

Compact, space saving alternative to our standard workstations, offering a distraction reducing workspace for younger pupils and featuring an acoustic attenuating panel which can be used as a noticeboard.



Workstations
Width 1050mm

WS2-590
H1300 x W1050 x D830
Desk Height: 590

WS2-640
H1300 x W1050 x D830
Desk Height: 640

WS2-710
H1300 x W1050 x D830
Desk Height: 710

WS2-760
H1300 x W1050 x D830
Desk Height: 760

WS4-590
H1300 x W1050 x D830
Desk Height: 590

WS4-640
H1300 x W1050 x D830
Desk Height: 640

WS4-710
H1300 x W1050 x D830
Desk Height: 710

WS4-760
H1300 x W1050 x D830
Desk Height: 760

Under Desk Storage
WS-UDU
H402 x W356 x D446



Small Workstations
Width 734mm

SWS-590
H1000 x W734 x D600
Desk Height: 590

SWS-640
H1000 x W734 x D600
Desk Height: 640

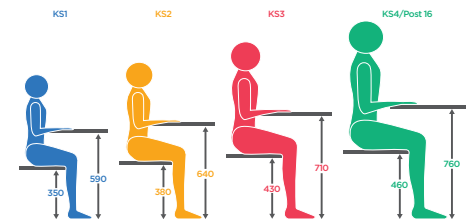

Chair and Table Height Ordering Guide (BS EN 1729)

COMPUTER DESKS

Secure Computer Desk

The secure computer desk is a flexible computer protection option for every environment.

Heavy duty construction and fully lockable the monitor is protected by our strong and durable polycarbonate screen offering long term value for money on equipment replacement. To suit 19" monitor.



Secure Computer Desk

SCD

H1273 x W1010 x D600 Desk Height 757
Beech only

Internal dimensions of screen housing:
H444 x W584 x D232

Fixed Computer Workstation

The Fixed Computer Workstation offers the best polycarbonate protection for computer equipment.

Heavy duty construction and fully lockable the monitor is protected by our strong and durable polycarbonate screen offering long term value for money on equipment replacement. To suit 19" monitor.



Fixed Computer Workstation

FCWS

H1300 x W1050 x D730 Desk Height 760

Internal dimensions of screen housing:
H444 x W584 x D232



STORAGE CUPBOARDS

A choice of a standard cupboard with tray storage system, and a unit with adjustable shelves. These units can be bolted together on request to create a custom classroom environment.

Lockable Tray Storage

Lockable Tray Storage designed to suit standard classroom trays.

Lockable Storage Cupboard

Lockable Storage Cupboard with additional shelves.

Wheeled Storage

Wheeled and movable under desk storage for workstations, designed to hold standard classroom trays.



Lockable Tray Storage

LTS
H869 x W1060 x D525
Without Trays

LTS-T
H869 x W1060 x D525
With Trays



Lockable Storage Cupboard

LSC
H869 x W1060 x D525



Wheeled Storage

TSU
H480 x W362 x D448 Without Trays

TSU-T
H480 x W362 x D448 With Trays

LOCK OPTIONS



L Lock
Comes as standard



SK Starkey Lock
Alternative lock option
on request

OPTIONAL EXTRAS

Replacement locks and keys.

RSK
Replacement starkey

RSKL
Replacement starkey lock

RK
Replacement key (numbered for
matching replacement)

RL
Replacement lock

TABLES

Height Adjustable Tables

Our height-adjustable tables are easy to adjust on a day to day basis: quick, smooth and safe adjustment with no tools on a table leg that operates on a step-by-step ratchet system. Each position is 20mm apart and the legs have an overall adjustment range of 200mm. There are two height ranges available: 530 - 730mm (S) and 730 - 930mm (T).

Height 530mm - 730mm

HT1-S

Square Height Adjustable Table
H530-730 x L900 x W900

HT2-S

Rectangular Height Adjustable Table
H530-730 x L1500 x W900

ST3-S

Cut-Away Height Adjustable Table
H530-730 x L1500 x W750

Height 730mm - 930mm

HT1-T

Square Height Adjustable Table
H730-930 x L900 x W900

HT2-S

Rectangular Height Adjustable Table
H730-930 x L1500 x W900

ST3-T

Cut-Away Height Adjustable Table
H730-930 x L1500 x W750



Heavy Duty Tables

ST1

Rectangular Table Unit
H760 x L1500 x W750

ST2

Semi-Circular Table
H760 x L1500 x W750



CLASSROOM CHAIRS



SC1

H513 x W360 x D320
(H260 to seat)

SC2

H563 x W363 x D343
(H310 to seat)

SC3

H600 x W340 x D384
(H350 to seat)

SC4

H690 x W432 x D408
(H380 to seat)

SC5

H799 x W480 x D486
(H425 to seat)

SC6

H829 x W482 x D510
(H455 to seat)

SC7

Linking Clip

Colours available for all sizes:
Green, Yellow, Red, Blue,
Purple, Lime, Sky & Orange

**Colours available for SC5
and SC6 only:** Grey,
Burgundy & Black

OPTIONAL EXTRAS



Please note

Our locks are supplied for fittings to Tough Furniture only.

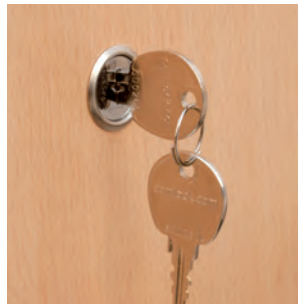

Numbered Individual Key Lock Set

Numbered for personal privacy and for ordering replacements. Master key available.

L

Available as standard on Tough Plus and Polycarbonate Units.

Replacement keys also sold separately.



Star Key Lock Set

For staff controlled access, needing only one universal key. Suitable for service users with learning difficulties.

SK

Available as standard on Tough Plus and PWS Window Protection.

Replacement keys also sold separately.



Inset Handles

Bolted through the door or drawer front.

IN

Available as standard on Tough Plus.



Sloping Top

Used in situations where climbing is an issue.

SP

Single Wardrobe

SP2

Double Wardrobe



Extra Shelves

Can be added to most cabinets.

ES



Inset Safety Mirror

Polycarbonate mirror recessed into the door.

H400 x W300

WM



Castors - set of 4

Can be fitted to some items.

CS



Bed Protection Tray

Moulded plastic tray to fit into the bed well of a single bed, providing hygienic management of incontinence problems.

Fits all single beds except Roxy.

PT

PTB (for TPBB)



Polycarbonate Base

To allow inspection for contraband.



Wallfix Preparation

Cabinets are fitted with brackets. Fittings are supplied. The back corners can be cut out to suit the skirting size, so the cabinet fits flat against the wall. The skirting size must be supplied to us on order to avoid delay to delivery. We require the height and depth of the skirting board.

WF

Available as standard on Tough Plus and floor standing polycarbonate units.

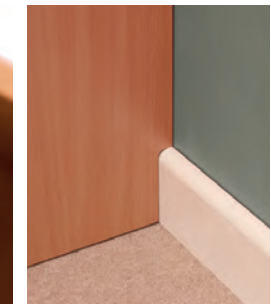
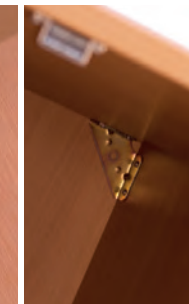

HOW TO ORDER

Easy to order

Tel: 01588 674 340

Fax: 01588 674 341

Email: sales@toughfurniture.com

Website: toughfurniture.com

Option 1:

Call or email us with your requirements and we will return a detailed written quotation for your approval within 24 hours.

Option 2:

Use the 'Request a Quote' function on our website. (See <https://www.toughfurniture.com/my-account/> for instructions.)

Option 3:

Provide an order directly in writing – please specify the quantity, name, code and colour option (where applicable), followed by the name and code of any optional extras

(if required - see page 46) and then the prices. For example:

1 x BC/Bedside Cabinet/Beech/£220

1 x L/Keylock/£28.35

Skirting cut-outs

If you require skirting cut-outs in a cabinet as part of the wall fix option, please send us the height and depth of your skirting as soon as possible to avoid delay to your delivery.

Lead times

All of our furniture is made to order, with an average lead time of 8-10 weeks. The exact timing of a delivery will be confirmed after order.

Confirmation of Order

Once your order has been received we will return a Confirmation of Order. Please check this carefully and contact us if you have any queries. If you don't receive a Confirmation, please contact us to check that we have received the order.

Prices and Payment Terms

Prices are nett and VAT must be added at the prevailing rate (unless an exemption applies and is confirmed).

Orders are accepted only under our standard terms and conditions (see www.toughfurniture.com/terms-and-conditions) unless agreed in writing otherwise.

Spares, repairs and maintenance

Our furniture is designed for ease of repair, so please call for spares or assistance if required. The most common request is for replacement locks and spare keys – see order codes below:

Replacement Key

RK

Replacement Lock

RL

Replacement Star Key

RSK

Replacement Star Key Lock

RSKL



Free delivery (for orders over £300)

The prices shown include delivery to the rooms (mainland UK) at a convenient time which we will confirm with you approximately a week beforehand. Our delivery personnel will leave the furniture ready to use and remove all packaging for recycling, but are not responsible for wall fixing or for clearing or removing any existing furnishings.

Small items may come by courier, and usually chairs and settees will arrive separately direct from our suppliers, although this will all be co-ordinated by ourselves, so contact us if you have any queries.

For safe delivery please ensure that all access is adequate, and contact us beforehand if there are any doubts or difficulties with this.

(In the event of agreed deliveries being refused or inaccessible then re-delivery charges may apply.)

Cleaning and Maintenance

Details of recommended cleaning and maintenance information arrive with the delivery and can also be found on our website:

<https://www.toughfurniture.com/customer-service/#maintenance>

All orders are subject to our terms and conditions which can be found on our website www.toughfurniture.com/terms-and-conditions





Tough Furniture Ltd

Stokewood Rd
Craven Arms Business Park
Craven Arms
Shropshire
SY7 8NR

Tel: 01588 674 340

Fax: 01588 674 341

Email: sales@toughfurniture.com

toughfurniture.com



ENVIRONMENTALLY FRIENDLY

At Tough Furniture we take seriously our environmental responsibilities in regard to the impact of all company activities on the environment